



**EUROTHERM
DRIVES**

601

Product Manual

© Copyright Eurotherm Drives Limited 1999

All rights strictly reserved. No part of this document may be stored in a retrieval system, or transmitted in any form or by any means to persons not employed by a Eurotherm group company without written permission from Eurotherm Drives Ltd.

Although every effort has been taken to ensure the accuracy of this document it may be necessary, without notice, to make amendments or correct omissions. Eurotherm Drives cannot accept responsibility for damage, injury, or expenses resulting therefrom.

WARRANTY

Eurotherm Drives warrants the goods against defects in design, materials and workmanship for the period of 12 months from the date of delivery on the terms detailed in Eurotherm Drives Standard Conditions of Sale IA058393C.

Eurotherm Drives reserves the right to change the content and product specification without notice.

© COPYRIGHT in this document is reserved to Eurotherm Drives Limited.

INTENDED USERS

The manual is to be made available to all persons who are required to configure, install or service the equipment described herein or any other associated operation.

SAFETY INFORMATION

Please read this section BEFORE installing the equipment

INTENDED USERS

This Guide is to be made available to all persons who are required to install, configure, or service equipment described herein or any other associated operation.

The information given is intended to highlight safety issues, and to enable the user to obtain maximum benefit from the equipment.

APPLICATION AREA

The equipment described is intended for industrial motor speed control applications utilising AC induction or AC synchronous machines.

PERSONNEL

Installation, operation and maintenance of the equipment should be carried out only by qualified personnel. A qualified person is someone who is technically competent and familiar with all safety information and established safety practices, with the installation process; operation, and maintenance of this equipment, and with all the hazards involved.

HAZARDS

This equipment can endanger life through rotating machinery and high voltages.

The equipment contains high value capacitors which take time to discharge after removal of the mains supply. Before working on the equipment ensure isolation of the mains supply from terminals L1, L2/N and L3 (as applicable). Wait for at least 3 minutes for the capacitors to discharge to safe voltage levels (<50 V)

Failure to do so constitutes AN ELECTRICAL SHOCK HAZARD.

When replacing a drive in an application, and before returning to use, it is essential that all user defined parameters for the product's operation are correctly installed.

Failure to do so may create A HAZARD AND RISK OF INJURY.

WARNING! The metal parts may reach 90° C.

APPLICATION RISK

The specifications, processes and circuitry described herein are for guidance only, and may need to be adapted to the user's specific application.

Eurotherm Drives does not guarantee the suitability of the equipment described in this Guide for individual applications.

RISK ASSESSMENT

Under fault conditions, power loss, or other operating conditions not intended, the equipment may not operate as specified. In particular:

- The motor speed may not be controlled.
- The direction of rotation of the motor may not be controlled.
- The motor may be energised.

IN ALL SITUATIONS

THE USER should provide guarding and/or additional safety systems to prevent risk of injury and electric shock.

CONTROL AND SIGNAL WIRING

All control and signal terminals are SELV, i.e., protected by double insulation. Ensure all wiring rated for highest system voltage.

ENCLOSURE

To maintain compliance with the Standard VDE0160(1994)/EN50178(1998) (used to demonstrate the 601 compliance with the Low Voltage Directive) the unit should be mounted inside a suitable control cubicle requiring a tool for opening.

RCDs

Compatible with RCDs which function normally with DC components of earth leakage current (Type B according to IEC 755/A2).

Contents	Page
Chapter 1 Product Overview	1-1
Description	1-1
Equipment Supplied	1-1
LED Display	1-3
Function Keys	1-3
Instruction Pullout Guide.....	1-4
Control Terminal Description	1-4
Power Terminal Description	1-5
Control Cable Retainer.....	1-5
Motor Cable Clamp	1-5
Cloning Connector	1-5
Chapter 2 Technical Details	2-1
Electrical Specification	2-1
Environmental Specification	2-2
Mechanical Specification	2-2
Chapter 3 Product Code	3-1
Chapter 4 Electrical Installation	4-1
Wiring Guidelines for EMC	4.1
Requirements for UL Compliance	4-4
Dynamic Braking Specification	4.5
Chapter 5 Operating Description	5-1
User Adjustable Parameters	5-1
Drive Status	5-5
Diagnostics	5-6
Selecting and Operating Local Mode.....	5-6
Chapter 6 Conformity	6-1
Chapter 7 Maintenance & Repair	7-1

PRODUCT OVERVIEW

DESCRIPTION

The 601 range of Frequency Inverters is designed for speed control of standard 3-phase induction motors. The range covers motor power ratings from 0.37kW ($\frac{1}{2}$ hp) to 2.2kW (3 hp).

The 601 features built in programming/operator controls and (optional) EMC compliant RFI filters. A pullout instruction guide provides quick reference for LED codes and terminal description.

Suitable members of the 601 range can operate from either a single phase two wire supply of 220/240 Volts or 3 wire 380 - 460 Volts supply, 50/60Hz.

The 400V 3-phase 601 range has an internal dynamic brake switch, this allows the user easy and convenient connection to an external resistor.

Advanced microprocessor technology provides a pulse width modulation strategy for quiet operation.

The 601 control terminals are SELV, i.e. double insulated from power circuits to allow easy and safe system interconnection.

The 601 is protected against overloads, excessive voltages and both phase to phase and phase to earth short circuits via an intelligent monitoring strategy. This avoids nuisance tripping and gives trouble free operation.

Optional internal RFI filters offer full electromagnetic compatibility (EMC) for the majority of applications without the need for additional external components. A comprehensive guide to EMC compliance is given in Chapter 6.

EQUIPMENT SUPPLIED

	Part Number	
1) 601 Frequency Inverter	See Product Code	
2) 601 Product Manual	HA464518	English (Multilingual)
	Including:-	French German Italian Spanish

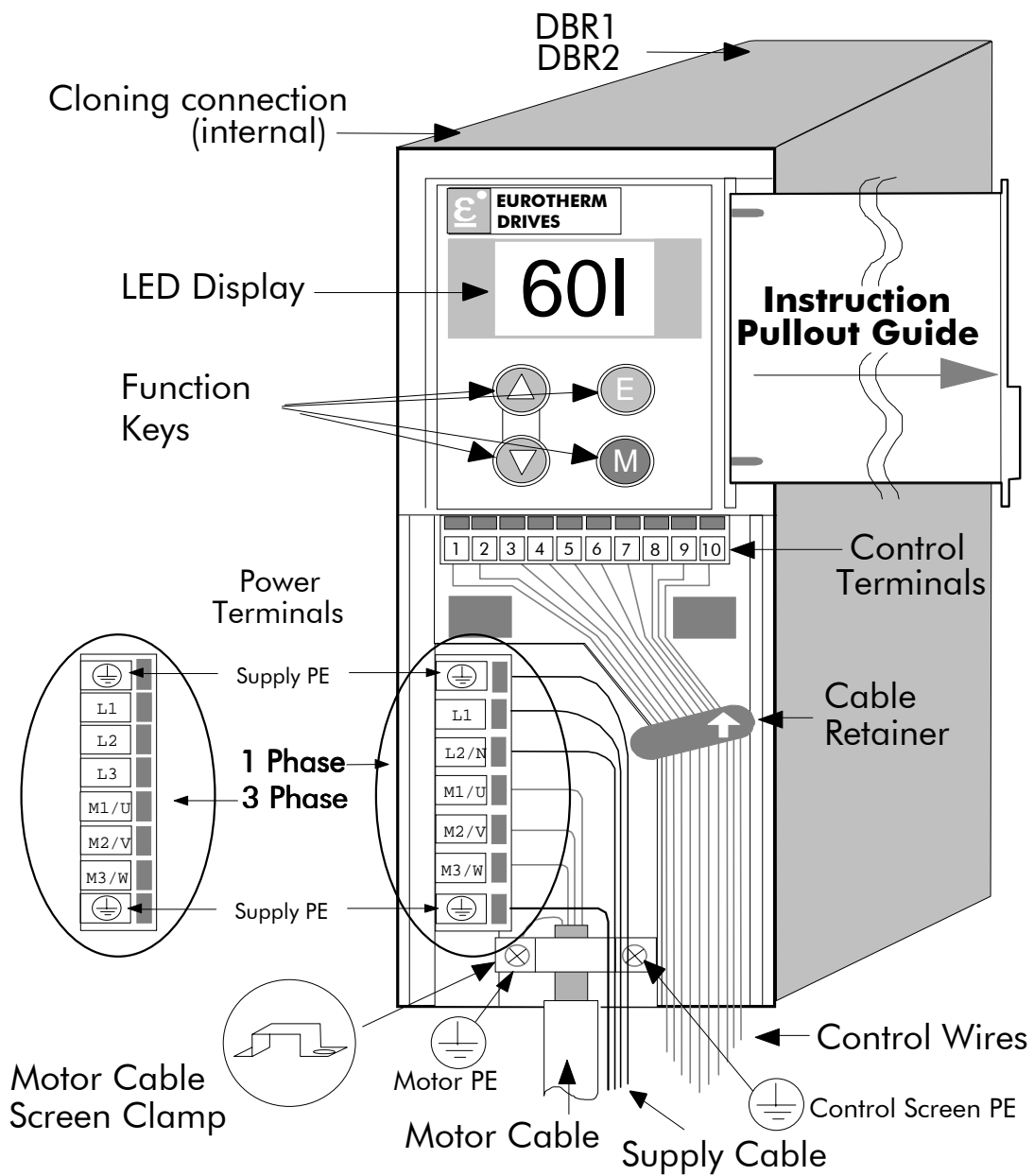
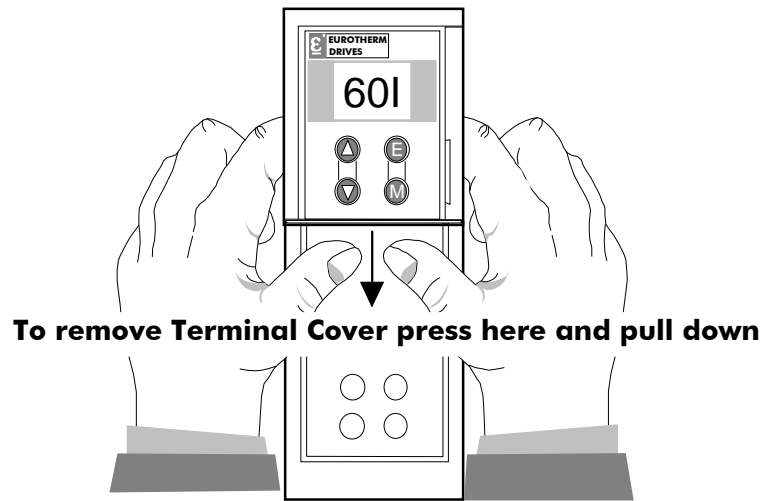

Figure 1.1: 601 with Terminal Cover Removed

1 - 3 Product Overview

LED DISPLAY

Three seven segment LED displays provide drive programming, status and diagnostic values. Refer to the following tables for further information:

- Table 5.1 for User Adjustable Parameters description (pages 5-1 and 5-2).
- Table 5.2 for Drive Status description (page 5-5).
- Table 5.3 for Diagnostics information (page 5-6).

FUNCTION KEYS

The Function Keys are used to navigate around the Man Machine Interface (MMI) structure as well as control the drive if LOCAL MODE is selected (See Chapter 5). The MMI “Tree” structure and function key operation is described in the following diagram.

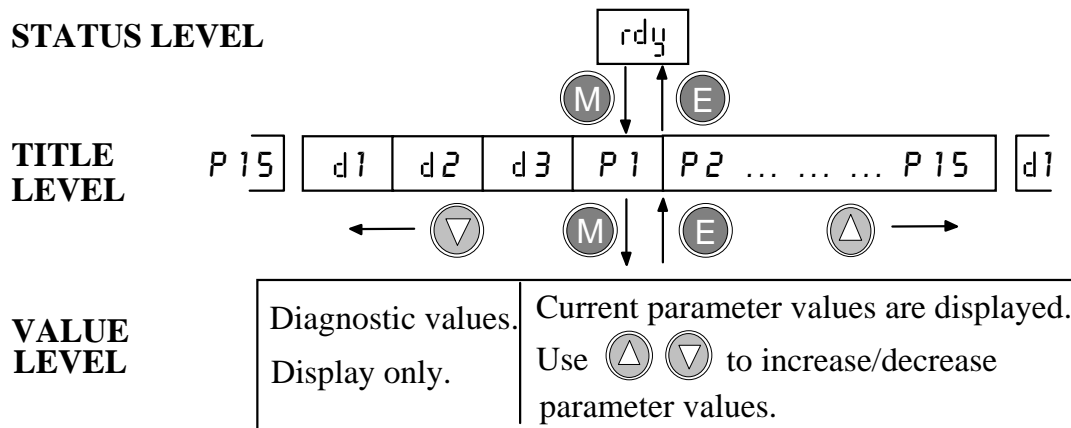

(Red)

MENU

This key is used to descend from **STATUS LEVEL** to **TITLE LEVEL** or from **TITLE LEVEL** to **VALUE LEVEL**.

This function key is also used to **stop** the drive when LOCAL mode is selected.



(Green)

ESCAPE

This key is used to ascend from **VALUE LEVEL** to **TITLE LEVEL** or from **TITLE LEVEL** to **STATUS LEVEL**. Note this action saves the selected parameter.

This function key is also used to **start** the drive when LOCAL mode is selected.



UP

This key is used to scroll through the **TITLE LEVEL** or increase parameter values.

This function key is also used to **increase the local setpoint and thus the inverter frequency** when LOCAL mode is selected



DOWN

This key is used to scroll through the **TITLE LEVEL** or to decrease parameter values. This function key is also used to **decrease the local setpoint and thus the inverter frequency** when LOCAL mode is selected.

INSTRUCTION PULLOUT GUIDE

This panel gives the user sufficient information for basic operation of the product:

- Translates the drive status information given in mnemonic form on the LED display (eg RDY = Ready; OC = Overcurrent).
- Decodes the titles of the parameters (P1 to P15) and the diagnostics (D1 to D3) shown on the LED display (eg D1 = Frequency).
- Where parameters are used to select an operating mode it decodes the numbers assigned to each mode (eg P11 mode 1 = Coast to Stop).
- Shows the function of each control terminal.

CONTROL TERMINAL DESCRIPTION

Terminal	Description	Function	Range	*Notes
1	0V reference for analogue I/O	0V	0V	8
2	Analogue input	Speed setpoint	0 - 10V	1, 2, 6
3	Current input	Speed setpoint	4 - 20mA	1, 3, 6
4	10V reference	For analogue I/O	10V \pm 5%	4
5	Analogue output	Ramp Output	0 - 10V	4, 6
6	24V supply	For digital I/O	50mA max	
7	Digital input	0 V = Stop 24V = Run	0 - 24V	5, 6
8	Digital input	0V = Forward 24V = Reverse Or preset select	0 - 24V	5, 6, 7
9	Digital input	0V = Stop 24V = Jog Or preset select	0 - 24V	5, 6, 7
10	Digital output - See Chapter 5	P14 Digital Output Select	0 - 24V open collector 50mA max	6

* Notes

Table 1.1

1. 10 bit resolution 0 - 10V, no sign.
2. Input Impedance 10k Ω ; absolute maximum input voltage 24 Volts DC
3. Input Impedance 250 Ω ; absolute maximum input voltage 7.87 Volts DC.
4. Absolute maximum output 10mA.
5. Logic low level < 5 Volts; Logic high level > 10 Volts, absolute maximum input voltage +30 -10 Volts DC.
6. Update time 10ms.
7. See page 4-5 for Preset configuration.
8. It is recommended that the "0V/common" be connected to protective earth/ground for safety reasons. In a system comprising of more than one controller, the "0V/common" signals should be connected together and joined to protective earth/ground at **one** point only. This is mandatory to meet the EMC specification stated.

POWER TERMINAL DESCRIPTION



Terminal	Description	Function	Range	Range
			200V 1 Phase	400V 3 Phase
	Reference Terminal	Supply protective earth (PE). This terminal must be connected to a protective (earth) ground for permanent earthing.		
L1	Power Input	Single and three phase live connection.	220/240V AC ±10% with respect to L2/N 50-60Hz (IT/TN)*	380/460V AC ±10% with respect to L2, L3 50-60Hz (IT/TN)*
L2/N	Power Input	Single phase neutral (or L2), three phase live connection.	220/240V AC ±10% with respect to L1 50-60Hz (IT/TN)*	380/460V AC ±10% with respect to L1, L3 50-60Hz (IT/TN)*
L3	Power Input	Three phase live connection.	Not applicable	380/460V AC ±10% with respect to L1, L2 50-60Hz (IT/TN)*
M1/U M2/V M3/W	Power Outputs	3-phase supply connection for motor.	0 to 220/240V AC 0 to 240Hz. (Delta connected)	0 to 380/460V AC 0 to 240Hz. (Star connected)
	Reference Terminal	Supply protective earth (PE). This terminal must be connected to a protective (earth) ground for permanent earthing.		

Table 1.2



* For products that are fitted with a filter (see Chapter 3 Product Code) an earth reference supply (TN) must be used.

CONTROL CABLE RETAINER

This clip is used to provide guaranteed segregation of the control and power cables. It may be rotated in either direction to allow easy installation of the control cables.

MOTOR CABLE CLAMP

In order to conform with the specified generic EMC standards **the motor cable must be screened and the screen connected to both the motor frame and the motor cable clamp**. This clamp is internally connected to power terminals PE (Protective Earth) and provides convenient 360° connection, and is used for the motor protective earth and motor and control cable screen connections as shown in figure 1.1.

CLONING CONNECTOR

This connector is located between the first and second top rib. It is intended to mate with an external data module. In order for the cloning function to operate, a compatible data module must be present (refer to Eurotherm Drives Sales Department).

TECHNICAL DETAILS

ELECTRICAL SPECIFICATION

PARAMETER	220/240 V ± 10% 1 Phase (IT/TN)*						UNITS
	0.37kW/ 0.5hp	0.55kW/ 0.75hp	0.75kW/ 1.0hp	1.1kW/ 1.5hp	1.5kW/ 2hp		
Max Supply Current 1ph	5.3	6.9	9.5	12.0	15.0		Amps AC (RMS)
Supply Fuse Rating 10 x 38 mm	10	10	10	20	20		Amps
Earth Leakage Current (Filtered)	7.5	7.5	7.5	7.5	7.5		mA
Max Output Current @ 40°C	2.2	3.0	4.0	5.5	7.0		Amps AC
Max Output Current @ 50°C	2.2	2.2	3.0	4.5	4.5		Amps AC
Heat Dissipation	22	32	42	55	70		Watts
	380/460 V ± 10% 3 Phase (IT/TN)*						
	0.37kW/ 0.5hp	0.55kW/ 0.75hp	0.75kW/ 1.0hp	1.1kW/ 1.5hp	1.5kW/ 2hp	2.2kW/ 3hp	
Max Supply Current 3ph	2.1	2.7	3.4	4.2	5.2	6.9	Amps AC (RMS)
Supply Fuse Rating 10 x 38 mm	10	10	10	10	10	10	Amps
Earth Leakage Current (Filtered)	10	10	10	10	10	10	mA
Max Output Current @ 40°C	1.5	2.0	2.5	3.5	4.5	5.5	Amps AC
Max Output Current @ 50°C	1.5	2.0	2.0	3.5	3.5	5.0	Amps AC
Heat Dissipation	13	18	23	31	41	54	Watts
Dynamic Braking Switch Specification	DBR Minimum Resistance 82 Ohms DBR Duty Cycle 100 % (continuous rating)						
ALL 601 RANGE							
Supply Frequency:	50/60Hz ±10%						
Power Factor (lag):	0.9 (@ 50/60Hz)						
Output Frequency:	0 - 240 Hz						
Overload:	150% for 30 seconds						
Supply Short Circuit Rating	5000 Amps						
Fuse Rating and Part Number:	10A	CH430014					
	20A	CH430024					
Fuse Holder 10 x 38 mm Part Number:	CP051602						

* Products fitted with a filter must only be used on earth referenced supplies (TN).

Table 2.1

2 - 2 Technical Details

ENVIRONMENTAL SPECIFICATION

Operating Temp		0 - 40°C (see Table 2.1 for current rating at 50°C)		
Storage Temp		-25 - +55°C		
Shipping Temp		-25 - +70°C		
Climatic Conditions		Class 3K3, as defined by prEN50178 (1995)		
Enclosure Rating		IP20 (UL Open Type) suitable for cubicle mount only.		
Altitude		Above 1000m derate 1% per 100m		
Humidity		Max. 85% Relative Humidity at 40°C		
EMC	Conducted Emissions	200V Single Phase		400V 3-Phase
		1.1kW & 1.5kW	0.37/0.55/0.75kW	(All)
		15m Motor Cable Maximum	25m Motor Cable Maximum	25m Motor Cable Maximum
		EN50081-1(1992)		EN50081-2(1994)
		Internal filter		
	Radiated Emissions	EN50081-1(1992) [all models] when mounted inside a cubicle providing 15dB electromagnetic radiation attenuation between 30 and 100MHz, screened control and motor cables outside of cubicle. Control 0V must be connected to protective earth/ground.		
	Immunity	prEN50082-2 (1992), EN50082-1 (1992)		
Safety		EN50178(1998), VDE 0160 (1994), Installation/Overvoltage Category 3, Pollution Degree 2 when fitted inside a suitable control cubicle.		

Table 2.2

MECHANICAL SPECIFICATION

The enclosure has IP20 ingress protection. A suitable control cubicle must be used where necessary to comply with local wall mount requirements. To maintain compliance with the European Electrical Safety Standard VDE0160(1994) / EN50178(1998) the 601 should be mounted inside a suitable control cubicle requiring a tool for opening.

Mounting

The 601 **must be mounted vertically** on a solid flat non-inflammable vertical surface either panel mounted or on a rail complying with EN50022 (35mm DIN). The unique dual action clip allows the 601 to be easily panel or DIN rail mounted.

ENGLISH

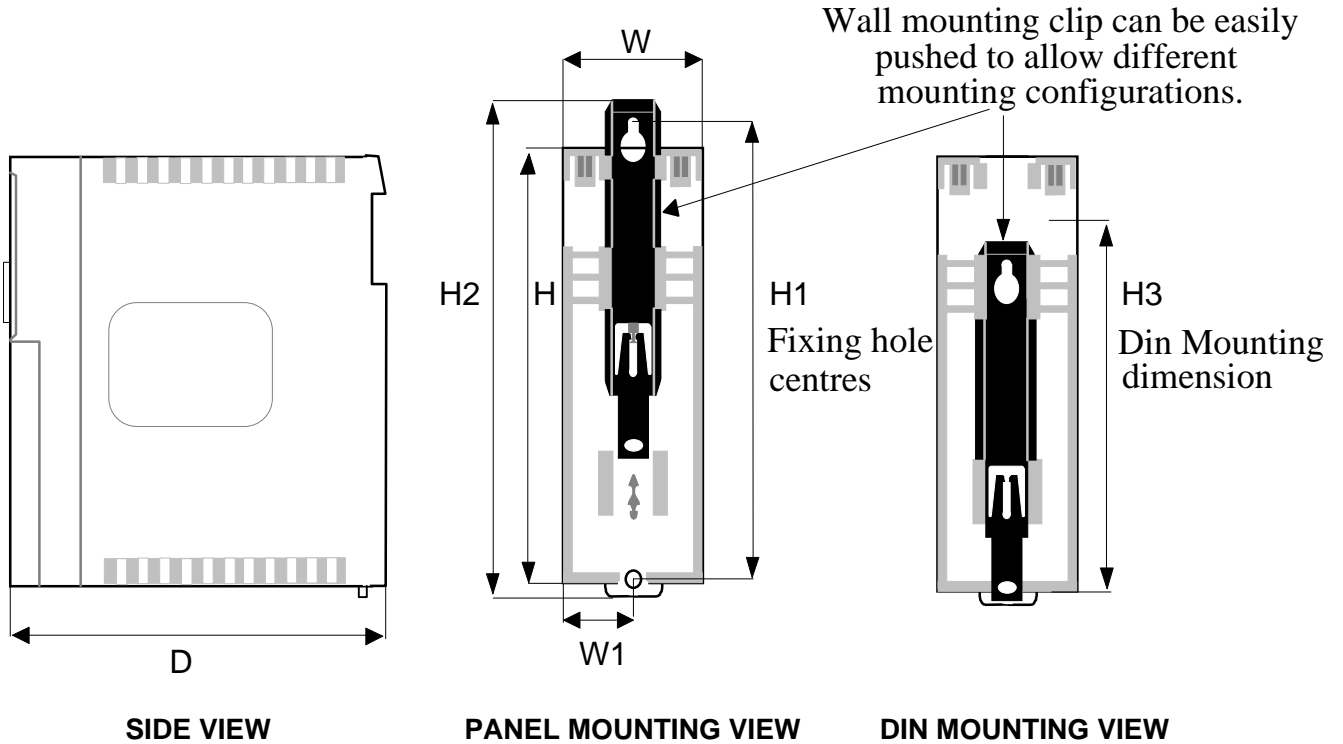

Figure 2.1

All Dimensions are in millimetres (inches)						
H	H1	H2	H3	W	W1	D
183.0 (7.20")	188.0 (7.4")	205.0 (8.07")	151.0 (5.94")	72.0 (2.83")	36.0 (1.41")	175.0 (6.89")
Fixings	Mounting Holes 5.5 mm. Use M5 fixings.					
Weight	220/240V Range 1.1 kg (2.5 lbs). 380/460V Range 1.5 kg (3.3 lbs).					
Maintain a minimum clearance for ventilation of 100 mm (4 in) above and below.						

Table 2.3

Ventilation

In normal operation the 601 dissipates heat and must therefore be mounted to allow the free flow of air vertically through the ventilation slots and heatsink. Care must be taken to ensure that the mounting surface is cool and that heat generated by other adjacent equipment is not transmitted to the 601. Provided the minimum clearance for ventilation is adhered to these products maybe mounted side-by-side.

PRODUCT CODE

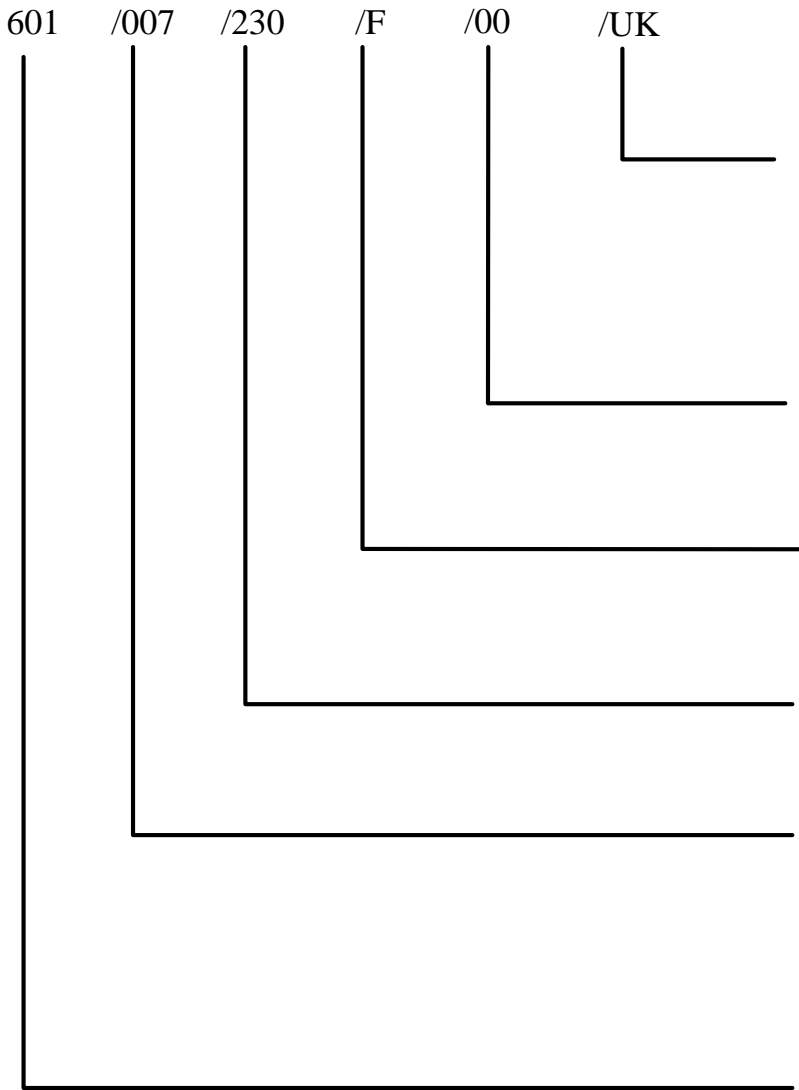

- Language ***
 - UK = English
 - FR = French
 - GR = German
 - IT = Italian
 - SP = Spanish
 - US = American English
- Livery**
 - 00 = Eurotherm Standard Livery
- Internal RFI Filter**
 - 0 = No Filter
 - F = Filter Fitted
- AC Supply Voltage +/- 10 %**
 - 230 = 220 / 240 V AC 1-Phase
 - 400 = 380 / 460 V AC 3-Phase
- Power Ratings**
 - 003 = 0.37 kW
 - 005 = 0.55 kW
 - 007 = 0.75 kW
 - 011 = 1.1 kW
 - 015 = 1.5 kW
 - 022 = 2.2 kW (400V only)
- Frequency Inverter**
 - 601

* The Language field specifies the instruction pullout guide and base frequency setting (see table 3-1 below).

Language	Instruction Pullout Guide	Default Base Frequency
UK	English	50 Hz
FR	French	50 Hz
GR	German	50 Hz
IT	Italian	50Hz
SP	Spanish	50 Hz
US	English	60 Hz

Table 3-1

ELECTRICAL INSTALLATION

Read the Safety Information at the front of the manual before proceeding.

WIRING GUIDELINES FOR EMC

The 601 series has been designed to comply with the European Community Directive 89/336/EEC on EMC. In particular the 601 meets the given generic emission and immunity standards specified in table 2.2 when suitably cubicle mounted and when the internal RFI filter option is fitted.

The following wiring guidelines must be followed to prevent interference with other electrical equipment.

Using Cage Clamp Terminals

Control and Power

To wire the control terminals or the power terminals (see figure 4-1):

- Remove the terminal cover as shown in figure 1.1.
- Insert a flat-bladed screwdriver (size 3.5 mm max.) inside the smallest hole.
- Lever the screwdriver keeping it firmly pressed into the hole. The cage will open.
- Insert the stripped wire (5mm to 6mm/0.22in.) or wire crimp inside the cage keeping the screwdriver in position.
- Remove the screwdriver. Note the cage provides the correct force for a secure connection.

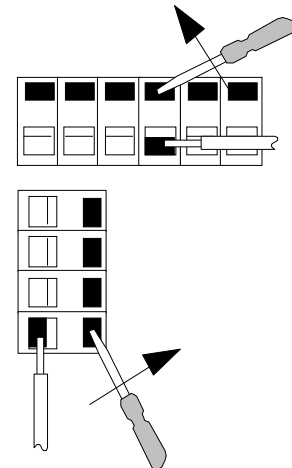

Figure 4.1

Dynamic Brake Terminal (400V only)

- Insert a flat-bladed screwdriver (size 3.5 mm max.) inside the hole as shown in figure 4.2.
- Press the screwdriver down, keeping it firmly pressed into the hole. The cage will open.
- Insert the stripped wire (5mm to 6mm/0.22in.) or wire crimp inside the cage keeping the screwdriver in position.
- Remove the screwdriver. Note the cage provides the correct force for a secure connection.

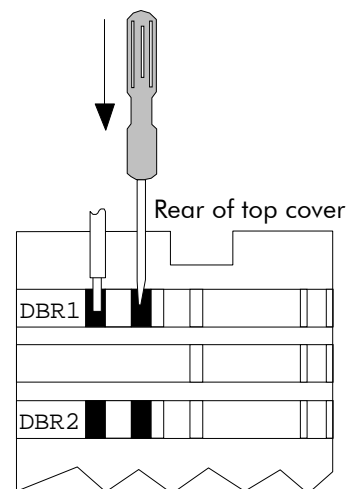

Figure 4.2

4 - 2 Electrical Installation

Control Cables

Control wiring should be segregated from all power wiring. To comply with the radiated emissions requirements of EN50081-1 the product must be inside a suitable control cubicle and the control cables must be screened outside of the cubicle. Connect the screen to earth at the 601 end only (see figure 4.3). Note the cubicle must provide 15dB attenuation to radiated emissions between 30 and 100MHz to meet the residential limits.

Motor Wiring

To meet the generic EMC Standards and minimise the electrical interference, connections between the Inverter and the motor must be made using screened cable. The screens must be connected to the motor frame and to the motor cable clamp (PE). The motor protective earth conductor should be connected at the drive end to the motor PE point. Where it is necessary to interrupt the screened cable for connection to circuit breakers or other devices, the screens should be connected over the shortest distance possible.

The motor cables should be segregated from **all** other wiring and should not be run in the same conduit/trunking as supply or control wiring. The recommended method for terminating the screen on screened motor cables is shown on the following figure.

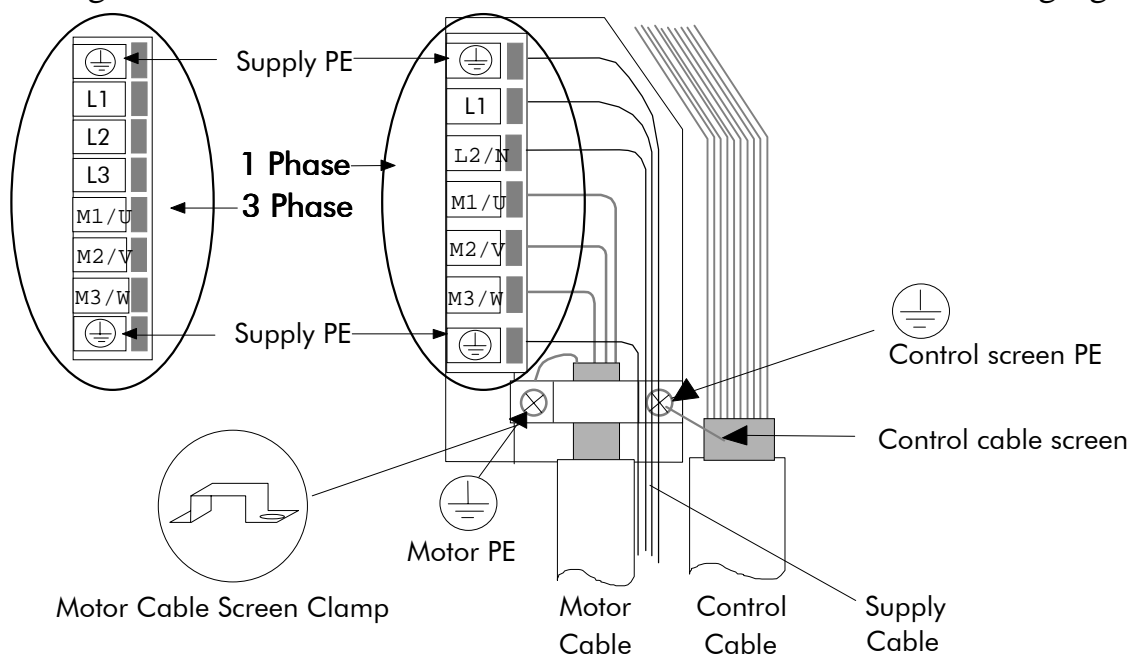

Figure 4.3

Power Wiring (Motor and Supply)

Remove terminal cover (figure 1.1). For typical power connections refer to figure 4.3.

Eurotherm Drives do not recommend the use of RCDs. If local regulations dictate their use, RCDs which function with DC components of earth leakage current (Type B as defined in IEC 755/A2) RCDs are only acceptable, otherwise all loads requiring protection with the RCD will be at risk. Filtered 601s must be **permanently earthed**

by using two independent protective earth incoming supply conductors (figure 4.3). This is due to the high earth leakage current when using filters.

The incoming mains supply should be protected by a suitable fuse or circuit breaker, as shown in table 2.1.

Power cables should be specified to this table:-

Current Rating	Cable size	Cable size
< = 8 Amps	1 mm ²	16 AWG
< = 10 Amps	1.5 mm ²	14 AWG
< = 15 Amps	2.5 mm ²	12 AWG

Table 4.1

When the wires are fully inserted into the terminal to maintain IP20 protection they need to be stripped to 5 - 6 mm (0.22 in).

Control Wiring

All control and signal terminals are SELV, i.e., protected by double/reinforced insulation. Ensure all wiring rated for highest system voltage. Control wiring of between 0.08 mm² (28 AWG) - 2.5 mm² (14 AWG) can be used.

Remove the terminal cover (see figure 1.1). Rotate the Control Cable Retainer, route the control cables in the right hand compartment and wire to the control terminals. Rotate the Control Cable Retainer to hold the cables in the designated compartment.

Figure 4.4 shows a typical control connections required for operation as a simple speed controller.

* It is recommended that the "0V/common" be connected to protective earth/ground for safety reasons. In a system comprising of more than one controller, the "0V/common" signals should be connected together and joined to protective earth/ground at one point only. This is mandatory to meet the EMC specification stated.

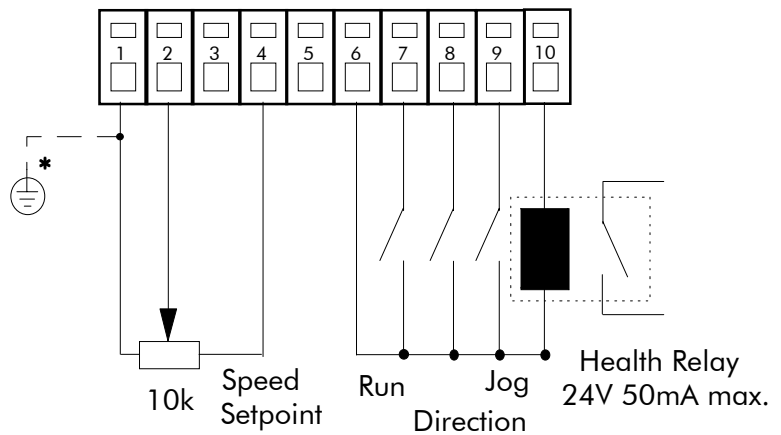

Figure 4.4

4 - 4 Electrical Installation

The terminal used to control the speed of the motor depends on the setting of Parameter P13 Setpoint Select as shown in Table 4.2 below:

Parameter 13	Control Terminal 8	Control Terminal 9	Setpoint Source
0	0V	0V	Control Terminal 2 (0-10V) - forward
	0V	24V	Jog Speed (set by Parameter P8) - forward
	24V	0V	Control Terminal 2 (0-10V) - reverse
	24V	24V	Jog Speed (set by Parameter P8)- reverse
1	0V	0V	Control Terminal 3 (4-20mA) - forward
	0V	24V	Jog Speed (set by Parameter P8) - forward
	24V	0V	Control Terminal 3 (4-20mA) - reverse
	24V	24V	Jog Speed (set by Parameter P8)- reverse
2	0V	0V	Preset Speed 1 (set by Parameter P1)
	24V	0V	Preset Speed 2 (set by Parameter P8)
	0V	24V	Preset Speed 3 (set by Parameter P9)
	24V	24V	Preset Speed 4 (set by Parameter P2)

Table 4.2

REQUIREMENTS FOR UL COMPLIANCE

Motor Base Frequency

The motor base frequency rating is 240Hz maximum

Field Grounding Terminals

The International Grounding Symbol \oplus (IEC Publication 417, Symbol 5019) is used to designate the field grounding terminals. Refer also to page 1-5, "Power Terminal Description"

Short Circuit Rating

All models are suitable for use on a circuit capable of delivering not more than 5000 RMS Symmetrical Amperes, 240/460V maximum.

Field Wiring Terminal Markings

For proper connections that are to be made to each terminal, refer to page 1-4, "Control Terminal Description" and page 1-5, "Power Terminal Description".

Field Wiring Temperature Rating

Use 60°C Copper Conductors only.

Terminal Tightening Torque

Terminals using automatic cage clamps are provided. Tightening torque is not applicable.

Internal Overload Protection

These devices provide Class 10 motor overload protection. The maximum internal overload protection level (current limit) is 150% for 30 seconds. Refer page 5-1 for user current limit adjustment information.

An external motor overload protective device must be provided by the installer where the motor used has a full-load ampere rating of less than 50% of the drive output rating.

Solid State Short Circuit Protection

These devices are provided with solid state short circuit (output) protection. Branch circuit protection should be provided as specified in the National Electrical Code, NEC/NFPA-70.

Power Wiring Terminals

The wiring terminals accept a maximum conductor size of No. 12 AWG (3.3mm²).

DYNAMIC BRAKING SPECIFICATION

During deceleration, or with an overhauling load, the motor acts as a generator. Energy flows back from the motor into the DC link capacitors within the Frequency Inverter. This causes the DC link voltage to rise. If the DC link voltage exceeds 810V then the Frequency Inverter will trip to protect the capacitors and the Inverter power devices. The amount of energy that can be absorbed in the capacitors is relatively small; typically more than 20 % braking torque will cause the Frequency Inverter to trip on overvoltage. Dynamic braking increases the braking capability of the Frequency Inverter by dissipating the excess energy in a high power resistor connected across the DC link. See Figure 4.5 for Dynamic Brake Switch specification.

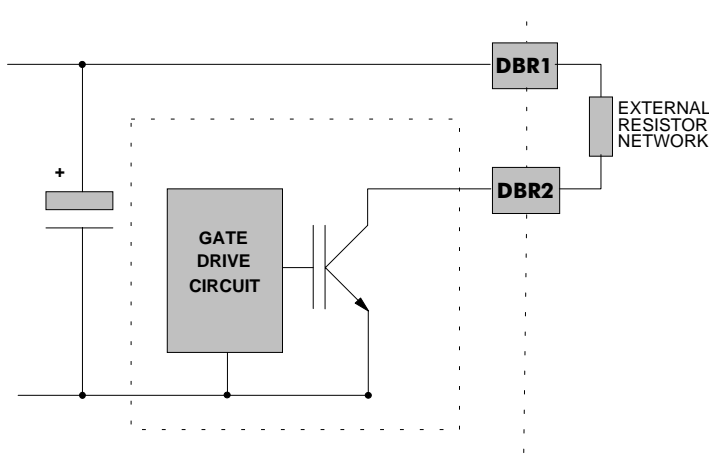

When the DC link voltage rises above 750 V, the brake unit switches the external resistor network across the DC link. The brake unit switches off again when the DC link voltage falls below the threshold level. The amount of energy produced by the motor during regeneration depends upon the RAMP DOWN TIME parameter and the inertia of the load.

Figure 4.5 Dynamic Braking Circuit

4 - 6 Electrical Installation

NOTE: THE DYNAMIC BRAKING CIRCUIT IS DESIGNED TO COPE WITH SHORT TERM STOPPING OR BRAKING ONLY.

IT IS NOT RATED FOR A CONTINUOUSLY OVERHAULING LOAD.

All 601 units are supplied without braking resistors. The following paragraphs should be used as a guide to calculate the braking requirements of the system.

Brake Resistor Selection

Brake resistor assemblies must be rated to absorb both peak braking power during deceleration and the average power over the complete cycle.

$$\text{Peak braking power} = \frac{0.0055J \times (n_1^2 - n_2^2)}{t_b} \quad (\text{W})$$

J - total inertia (kgm²)

n₁ - initial speed (rpm)

n₂ - final speed (rpm)

t_b - braking time (s)

t_c - cycle time (s)

$$\text{Average braking power } P_{av} = \frac{P_{pk}}{t_c} \times t_b$$

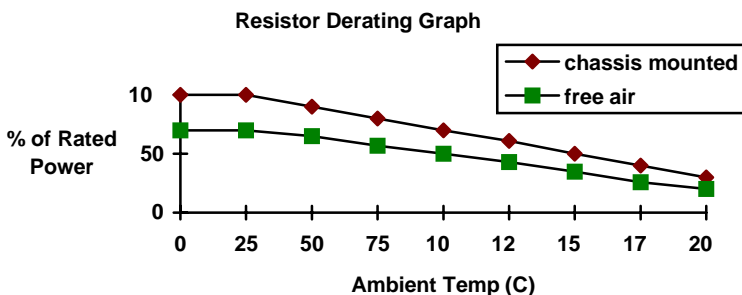
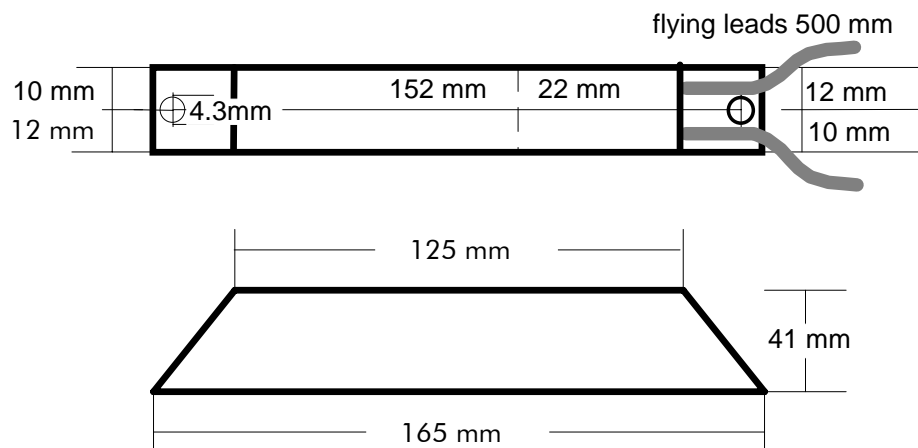

Eurotherm Part N ^o	CZ389853
Resistance	100 ohms
Max Wattage	100 W
5 second rating	500 %
3 second rating	833 %
1 second rating	2500 %

Figure 4.6 Braking Resistor Performance

These resistors should be mounted on a heatsink (back panel) and covered to prevent injury from burning.

OPERATING DESCRIPTION

The 601 can be controlled in two different ways:

1. Remote Mode using the analogue and digital i/o on the control terminals.
2. Local Mode using the keypad.

On the LED display, the User Adjustable Parameters are identified as P1 to P15 (see table 5.1), the Drive Status is shown using mnemonics (table 5.2), and the Diagnostics are identified as D1-D3 (table 5.3).

The 601 has parameters factory defaults which are adequate for most applications. However, it may be necessary to change some Parameters to suit individual installations (see Chapter 1).

Parameters Base Frequency (P7), and Bit Parameters (P11-P15) cannot be changed when the motor is running. No Parameter (P1-P15) can be changed when the 601 is in Local Mode.

USER ADJUSTABLE PARAMETERS

Title	Translation	Description	Range	Factory Default
P 1	Minimum Speed or (Preset 1)	The frequency at which the 601 will run when zero setpoint is applied unless clamped by P2	0-240 Hz	0Hz
P 2	Maximum Speed or (Preset 4)	The frequency at which the 601 will run when Maximum Setpoint is applied	0-240 Hz	50/60Hz
P 3	Ramp Up Time	The time taken for the 601 output frequency to ramp up from zero to Maximum Speed	0.1-999s	10s
P 4	Ramp Down Time	The time taken for the 601 output frequency to ramp down from Maximum Speed to zero	0.1-999s	10s
P 5	Current Limit	Limits the output current to the percentage value specified. The 601 will automatically reduce the output frequency in order to stay within this limit	50 - 150 %	100 %
P 6	Voltage Boost	(Detailed over)	0 - 25 %	5 %

5 - 2 Operating Description

Title	Translation	Description	Range	Factory Default
P 7	Base Frequency	The output frequency at which maximum voltage is reached.	25-240 Hz	50/60Hz (see 3-1)
P 8	Jog Speed or (Preset 2)	The speed at which the 601 will run if Control Terminal 9 is high	0-240 Hz	10Hz
P 9	Preset Speed 3	The speed at which the 601 will run when P13 = 2, Control Terminal 8 is low and Control Terminal 9 is high	0-240 Hz	25Hz
P 10	Password	A password may be set to prohibit unauthorised adjustment of Parameters. When P10 is set to non-zero the user will be required to match the last saved value before Parameters can be adjusted	0 - 999	0
P 11	Stopping Mode	(Detailed over)	0=Ramp 1=Coast 2=Injection	0
P 12	V/F Shape	(Detailed over) Range 2 and 3 of this parameter disables the stall Trip function.	0=Linear 1=Quadratic 2=Linear 3=Quadratic	0
P 13	Setpoint Select	A method of programming the source of the Setpoint - see Table 4.2	0=0 - 10V 1=4 - 20mA 2=Presets	0
P 14	Digital Output Select	(Detailed over)	0=Healthy 1=Running 2=Min Speed 3=At Speed	0
P 15	Parameter Copying Mode	(Detailed over)	0=Normal 1=Read External 2=Write External	0

Table 5.1

P6 Voltage Boost

This is used to correctly flux the motor at low speeds. This allows the drive to produce greater starting torque for high friction loads. The **VOLTAGE BOOST** parameter increases the motor volts above the selected V/F characteristic at the lower end of the speed range.

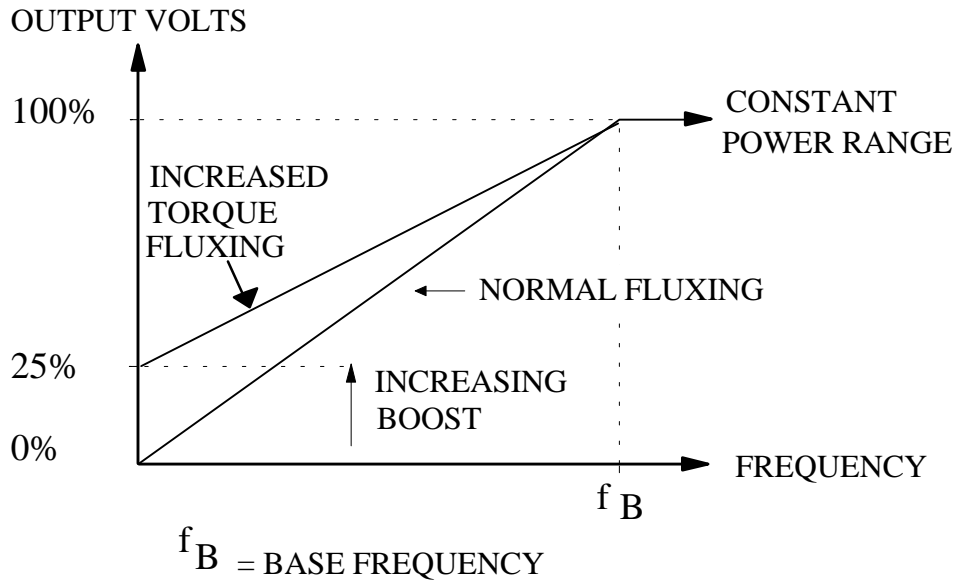

P11 Stopping Mode

A choice of three stopping modes are available:

- RAMP** The motor speed is reduced down to zero at a rate set by the **RAMP DOWN TIME** parameter (P4). A 2 second pulse is applied at end of ramp.
- COAST** The motor is allowed to freewheel to a standstill.
- INJECTION** On a stop command the motor volts are rapidly reduced at constant frequency to deflux the motor. A low frequency braking current is then applied until the motor speed is almost zero. This is followed by a timed DC pulse to hold the motor shaft. Braking current during the injection stopping sequence is controlled by the **CURRENT LIMIT** parameter (P5).

5 - 4 Operating Description

P12 V/F Shape

The **V/F SHAPE** parameter enables one of two voltage/frequency characteristics to be selected;

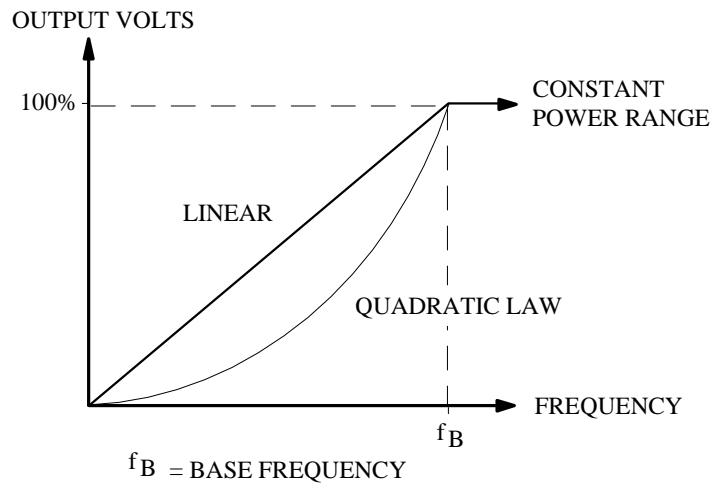

LINEAR This gives a constant flux characteristic up to the **BASE FREQUENCY**.

QUADRATIC This gives a quadratic flux characteristic up to the **BASE FREQUENCY**. This matches the load requirement for fan and most pump applications.

P14 Digital Output Select

Value	Name	Description
0	Healthy/Unhealthy	Control terminal 10 will be held low when no trips are present.
1	Running/Not running	Control terminal 10 will be held low when the motor is running.
2	At min speed/above min speed	Control terminal 10 will be held low when the output frequency is at/or below minimum speed setting P1.
3	At speed/not at speed	Control terminal 10 will be held low when the output frequency is within $(0.0015 \times \text{Max Speed (P2)})$ of setpoint.

P15 Parameter Copying Mode

This parameter will always display zero when the value level is first entered.

Selecting Mode 1 (by pressing \triangle once then pressing \textcircled{M}) will copy a configuration to the 601 from a compatible external device.

Selecting Mode 2 (by pressing \triangle twice then pressing \textcircled{M}) will copy the current 601 configuration to a compatible external device.

If copying and verifying the configuration is successful the display will revert to 0, otherwise an “Err” status message will be displayed.

DRIVE STATUS



Title	Description	Possible Cause
rdy	READY/HEALTHY (No Alarms Present).	
OC	OVERCURRENT. 601/003/230 - 601/007/230 22A 601/003/400 - 601/015/400 22A 601/011/230 - 601/015/230 44A 601/022/400 30A	Ramp Up Time too short for inertia of load and/or power rating of 601. Ramp Down Time too short for inertia of load and/or power rating of 601. Application of shock overload. Short circuit between motor phases. Short circuit from motor phase to earth. Motor cables too long or too many parallel motors. Voltage Boost set too high.
OU	OVERVOLTAGE. DC bus voltage exceeded 410 V dc. (810 V dc for 400 V 3-phase version).	The supply voltage is too high. Ramp Down Time too short for load inertia/power rating.
IL	1 x t OVERLOAD. Cumulative overload at 150% current for 30 seconds.	Load is too high. Voltage Boost set too high.
St	STALL. Drive was in current limit for more than 200 seconds.	Load is too high. Voltage Boost set too high.
OT	OVERTEMPERATURE. Heatsink temperature exceeded 100° C.	Ambient temperature too high. Poor ventilation.
Err	SAVING ERROR. Problem saving Parameters to EEPROM.	External device present or not compatible. A power supply problem occurred during saving.
CL	CURRENT LOOP LOSS. 4 - 20 mA setpoint current less than 1mA.	A current of less than 1mA is present when 4-20mA setpoint is selected.
PR5	PASSWORD. Current password must be entered before this parameter may be altered.	Enter password to change the parameter.
---	PASSWORD INCORRECT. Wrong password entered.	Current password does not match entered password.
LOC	LOCAL. Local mode selected	Detailed over.
rSt	RESET. Factory default reset	Detailed over.
UU	UNDERVOLTAGE Bus voltage has fallen below 200 Volts dc (400V dc for 400V 3-phase version).	Supply voltage has been interrupted or gone below specification.

Table 5.2

5 - 6 Operating Description

When a trip occurs a status message is flashed (de-coded by the above table 5.2). When the RUN command is removed the status message will stop flashing if the alarm has cleared. This will bring low control terminal 10 if Healthy/Unhealthy has been selected parameter P14 = 0. This places the product into a state where the RUN command can be re-applied and if the alarm does not reoccur the product will run normally.

Reset to Factory Default Values













All parameters can be returned to factory default settings by powering up the 601 while both   keys are pressed simultaneously.

DIAGNOSTICS



Title	Description
d1	FREQUENCY. This diagnostic gives the current output frequency in Hz.
d2	SET POINT. This diagnostic gives the set point frequency in Hz.
d3	LOAD. This diagnostic gives current load value as % of 601 rating.

Table 5.3

SELECTING AND OPERATING LOCAL MODE

To select Local mode press   simultaneously from the status level and stopped. The display will begin to spell **L O C**. When all three letters are displayed and the word **L O C** is flashing release the   keys or the display will revert back to **Rd Y** (remote mode). The display now shows the local setpoint which can be increased using the  or decreased using the  key. The  (green) key can be used to start the 601 and the  (red) key can be used to stop the 601. While in the stopped state pressing the  key will show the current direction. This direction may be changed by holding down the  key while simultaneously pressing either the  key for **F F W** (forward) or the  key for **R E V** (reverse).

To clear a fault, press .

To return to **Rd Y** (remote mode) press  and  simultaneously. For safety, the drive will not return to the remote mode if this will cause the drive to start. In this event the display will flash. Check RUN and JOG inputs are low.

EMC AND THE 'CE' MARK

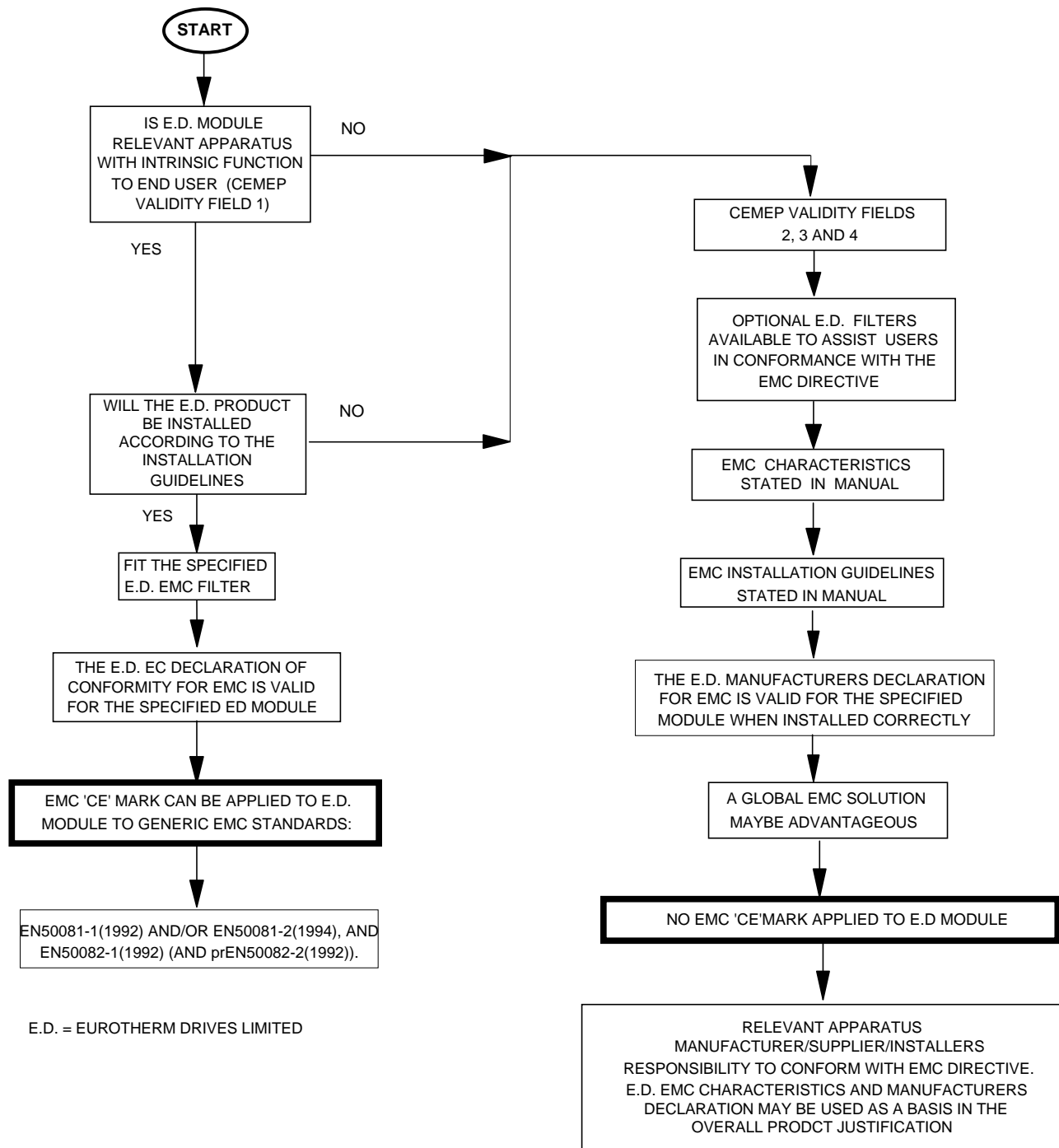

Figure 6.1 Eurotherm EMC 'CE' Mark Validity Chart

For more information refer to EMC Application Manual HA388879

MAINTENANCE AND REPAIR

MAINTENANCE

Routine maintenance of the 601 comprises a periodic inspection to check for a build-up of any dust, or other obstructions, that may affect the ventilation of the unit.

Obstructions should be removed and any dust must be cleared using dry air.

REPAIR

The 601 contains no user serviceable component and **MUST NOT BE REPAIRED** by the user.

If repair is necessary, return the unit to Eurotherm Drives.

RETURNED MATERIAL

The following procedures are recommended in the event of a fault which necessitates return of an item to Eurotherm Drives.

You will require the following information:

1. The model and serial number of the faulty item.
2. Details of the fault.

Contact your nearest Eurotherm Drives Service Centre to arrange return of the item. Refer to the list of Eurotherm Drives Service Centres at the end of this Guide.

On contacting your local Eurotherm Drives Service Centre you will be given a ***Returned Material Authorisation*** code which must be used as a reference on all paperwork returned with the equipment.

Pack and despatch the item.

Supply Harmonic Analysis

Assumptions: 5000A short circuit supply capability, equivalent to 146μH supply impedance

$$THD(V) \times 100 = \frac{\sqrt{\sum_{h=2}^{h=40} O_h^2}}{O^{1n}} \%$$

where Q_{1n} is the rated rms value of the fundamental voltage of the supply transformer.

The results conform to stage 1, stage 2 and stage 3 of the Engineering Recommendation G.5/3 September 1976, Classification 'C': Limits for Harmonics in the UK Electricity Industry.

Drive Type	Three Phase						Single Phase				
601 Type	C	C	C	C	C	C	A	A	A	B	B
Motor Power(kW)	0.37	0.55	0.75	1.1	1.5	2.2	0.37	0.55	0.75	1.1	1.5
Fundamental Voltage (V)	400	400	400	400	400	400	230	230	230	230	230
Typical Motor Efficiency	70%	72%	73%	77%	80%	81%	70%	72%	73%	77%	80%
Harmonic N ^o .	RMS Current (A)										
1	1.0	1.3	1.7	2.3	2.9	4.1	2.4	3.3	4.6	6.1	8.2
3							2.4	3.2	4.4	5.8	7.8
5	0.9	1.2	1.6	2.1	2.6	3.6	2.2	2.9	4.1	5.3	7.0
7	0.9	1.2	1.5	1.9	2.3	3.2	2.0	2.5	3.6	4.5	5.9
9							1.8	2.1	3.0	3.7	4.6
11	0.7	1.0	1.2	1.4	1.7	2.1	1.5	1.8	2.4	2.8	3.3
13	0.6	0.8	1.0	0.6	1.3	1.5	1.2	1.4	1.8	1.9	2.2
15							0.9	1.1	1.2	1.2	1.2
17	0.5	0.6	0.7	0.4	0.6	0.6	0.6	0.7	0.7	0.6	0.5
19	0.4	0.5	0.5	0.1	0.4	0.3	0.4	0.4	0.3	0.2	0.2
(21-39)	<0.2	<0.3	<0.3	<0.1	<0.2	<0.2	<0.1	<0.1	<0.2	<0.2	<0.3
Total RMS Current (A)	2.1	2.7	3.4	4.2	5.2	6.9	5.3	6.9	9.5	12.0	15.0
THD (V) %	0.4	0.4	0.6	0.6	0.7	0.9	0.8	1.0	1.2	1.4	1.8

EC Declaration of Conformity for EMC



EC DECLARATION OF CONFORMITY

In accordance with the EEC Directive 89/336/EEC,
Article 10 and Annex 1, (EMC DIRECTIVE)

We Eurotherm Drives Limited, address as below, declare under our sole responsibility that the following Electronic Products

601(0.37KW-1.5KW) Single Phase
601(0.37KW-2.2KW) Three Phase

When installed, used and CE marked in accordance with the instructions in the Product Manual (provided with each piece of equipment) using the specified EMC filters to which this declaration refers is in Conformity with the following standards:-

601(0.37KW-1.5KW) single phase: BSEN50081-1 (1992), BSEN50081-2 (1994),
draft prEN50082-2[#]* (1992) & BSEN50082-1[#] (1992).

601(0.37KW-2.2KW) Three Phase : BSEN50081-2 (1994) for conducted emissions,
BSEN50081-1 (1992) & BSEN50081-2 (1994) for radiated emissions,
draft prEN50082-2[#]* (1992) & BSEN50082-1[#] (1992).

Following provisions of EEC- Directive
89/336/EEC with amendments 92/31/EEC and 93/68/EEC

30th January 1998

.....
Dr Martin Payn,
Conformance Officer
Eurotherm Drives Ltd.

.....
Dr Dan Slattery,
Technical Director
Eurotherm Drives Ltd.

.....
Date

* For information only.

Compliant with these immunity standards without specified EMC filters.

EUROTHERM DRIVES LIMITED

NEW COURTWICK LANE, LITTLEHAMPTON, WEST SUSSEX BN17 7PD
TELEPHONE: 01903 721311 FAX: 01903 723938

Registered Number: 1159876 England. Registered Office: Leonardslee, Lower Beeding, Horsham, West Sussex RH13 6PP

© 1998 EUROTHERM DRIVES LIMITED

File Name: P:\PRODUCTS\CE\EMC\PRODUCTS\601C\PRODFILEHK464351.911

ISS:	DATE	DRN: NS	DRAWING NUMBER:	HP464351.C911
A	30-1-98	CHKD: MP	TITLE:	SHT 1 OF 1 SHTS
			601 EC Declaration of Conformity for EMC	

Issue D 20.02.1995 GA387648C017

Manufacturers EMC Declaration**EUROTHERM
DRIVES****MANUFACTURERS EMC DECLARATION**

In accordance with the EEC Directive 89/336/EEC, Article 10 and Annex 1, (EMC DIRECTIVE)

We Eurotherm Drives Ltd., address as below, declare under our sole responsibility that the following electronic products

601(0.37KW-1.5KW) Single Phase
601(0.37KW-2.2KW) Three Phase

when installed and used in accordance with the instructions in the product manual (provided with each piece of equipment) and using the specified EMC filters to which this declaration refers is in conformity with the following standards:-

601(0.37KW-1.5KW) Single Phase : BSEN50081-1 (1992), BSEN50081-2 (1994), draft prEN50082-2^{#*} (1992) & BSEN50082-1[#] (1992).

601(0.37KW-2.2KW) Three Phase : BSEN50081-2 (1994) for conducted emissions, BSEN50081-1 (1992) & BSEN50081-2 (1994) for radiated emissions, draft prEN50082-2^{#*} (1992) & BSEN50082-1[#] (1992).

30th January 1998

.....
Dr Martin Payn,
Conformance Officer
Eurotherm Drives Ltd

.....
Dr Dan Slattery,
Technical Director
Eurotherm Drives Ltd

.....
Date

Compliant with these immunity standards without specified EMC filters.

* For information only.

EUROTHERM DRIVES LIMITED

NEW COURTWICK LANE, LITTLEHAMPTON, WEST SUSSEX BN17 7PD

TELEPHONE: 01903 721311 FAX: 01903 723938

Registered number: 1159876 England. Registered Office: Leonardslee, Lower Beeding, Horsham, West Sussex RH13 6PP

© 1998 EUROTHERM DRIVES LIMITED

File Name: P:\PRODUCTS\CE\EMC\ PRODUCTS\601C\PRODFILE\HK464351.913				
ISS:	DATE	DRN: NS	DRAWING NUMBER: HK464351C913	
A	30-1-98	CHKD:	TITLE: 601Manufacturers EMC Declaration	SHT 1 OF 1 SHTS
		 EUROTHERM DRIVES		

Issue D 20.02.1995 GA387648C017

EC Declaration of Conformity for Electrical Safety



EC DECLARATION OF CONFORMITY

In accordance with the EEC Directive 73/23/EEC and amended by 93/68/EEC, Article 13 and Annex III, (LOW VOLTAGE DIRECTIVE)

We Eurotherm Drives Limited, address as below, declare under our sole responsibility that the following Electronic Products

- 601 (0.37kW - 1.5kW) Single Phase**
- 601 (0.37kW - 2.2kW) Three Phase**

When installed and operated with reference to the instructions in the Product Manual (provided with each piece of equipment) is in accordance with the following standard:-

VDE0160(1994)/EN50178(1998)

Following provisions of EEC-Directive 73/23/EEC with amendment 93/68/EEC

8th January 1999

.....
 Dr Martin Payn,
 Conformance Officer
 Eurotherm Drives Ltd

.....
 Dr Dan Slattery,
 Technical Director
 Eurotherm Drives Ltd

.....
 Date

EUROTHERM DRIVES LIMITED

NEW COURTWICK LANE, LITTLEHAMPTON, WEST SUSSEX BN17 7PD
 TELEPHONE: 01903 721311 FAX: 01903 723938

Registered number: 1159876 England. Registered Office: Leonardslee, Lower Beeding, Horsham, West Sussex RH13 6PP

© 1998 EUROTHERM DRIVES LIMITED

File Name: P:\CE\AFETY\PRODUCTS\601C\PRODFILE\HK464462.955				
ISS:	DATE	DRN: MPC	DRAWING NUMBER:	HK464462C955
B	08.01.99	CHKD: MP	TITLE:	SHT 1 OF 1 SHTS
			601 (0.37kW - 1.5kW) 1Ø 601 (0.37kW - 2.2kW) 3Ø EC Declaration of Conformity for Electrical Safety	

Issue D 20.02.1995 GA387648C017

Machinery Directive**MANUFACTURER'S DECLARATION**

The following Electronic Products

601 (0.37kW - 1.5kW) Single Phase

601 (0.37kW - 2.2kW) Three Phase

are components to be incorporated into machinery and may not be operated alone.

The complete machinery or installation using this equipment may only be put into service when the safety considerations of the Directive 89/392/EEC are fully adhered to.

Particular reference should be made to EN60204-1 (Safety of Machinery - Electrical Equipment of Machines).

All instructions, warnings and safety information of the Product Manual must be adhered to.

.....
Dr Martin Payn,
Conformance Officer
Eurotherm Drives Ltd

.....
Dr Dan Slattery,
Technical Director
Eurotherm Drives Ltd

29th January 1998

.....
Date

EUROTHERM DRIVES LIMITED

NEW COURTWICK LANE, LITTLEHAMPTON, WEST SUSSEX BN17 7PD

TELEPHONE: 01903 721311 FAX: 01903 723938

Registered number: 1159876 England. Registered Office: Leonardslee, Lower Beeding, Horsham, West Sussex RH13 6PP

© 1998 EUROTHERM DRIVES LIMITED

File Name: P:\601\DOCS\MANUAL\ENGLISH\464518\ISSUE3\DECLARA.WRD				
ISS:	DATE	DRN: MPC	DRAWING NUMBER: HK464462C918	
A	29.01.98	CHKD: MP	TITLE:	
			601 (0.37kW - 1.5kW) 1Ø 601 (0.37kW - 2.2kW) 3Ø Machinery Directive	
			SHT 1 OF 1 SHTS	

Issue D 20.02.1995 GA387648C017

ISS	MODIFICATION	ECN No.	DATE	DRAWN	CHK'D
1	Initial Issue HA464518 Introduction of 400V 3-phase range and Version 2 Software.	12165	28.02.98	FEP	WS
2	Page 2-2 added 15m motor cable to 200V 1.1kW and 1.5kW.	12868	31.07.98	FEP	MP
	Corrections to German translation on pages 1-4, 4-2, 4-5, 4-6, and 5-6.	12995	19.08.98		
3	Replaced prEN50178(1995) with EN50178(1998) and updated EC Declaration of Conformity.	13114			
	Removed address list from inside manual to back cover.	13164			
	German version page 2-1 corrected 1 phasig to 3 phasig and spelling corrections on pages 5-6, 4-5 and 4-6.	13174	8.01.99	FEP	CM
FIRST USED ON		MODIFICATION RECORD			
		601 Product Manual			
 EUROTHERM DRIVES		DRAWING NUMBER			SHT. 1
		ZZ464518			OF 1