

2408i

MODEL



Model 2408i
1/8 DIN (96 x 48mm)



EUROTHERM

CONTROLS
PROCESS AUTOMATION
RECORDERS

Ideal for:

- Temperature indication
- Pressure, flow and level monitoring
- Differential measurements
- Data acquisition and transmission
- Process protection
- Weighing platform
- Strain gauge inputs
- Melt pressure indication

Features:

- **Four alarm setpoints** For operator alert and plant protection
- **Custom linearisation** 15 point custom table for specialised sensors
- **Digital communications** With Modbus®, ASCII and Profibus-DP protocol for supervisory control and data logging
- **DC retransmission** Fully isolated trouble-free retransmission to remote control and monitoring equipment
- **Remote setpoint input** To which deviation alarms can be applied.
- **INSTANT ACCURACY™** Cold junction sensing technology eliminates warm-up errors
- **Alarm functions** Selectable on PV1, PV2 and main PV inputs
- **Auto calibration tare function** Weighing platform/strain gauge inputs may be easily calibrated prior to measurement. Ref HA027223 for further information.
- **Plug-in from front** For rapid replacement - reducing downtime
- **Three year warranty** Low ownership cost

Universal Indicator and Alarm Unit

Accurate, stable measurement of temperature, pressure, level, flow and other process variables are provided by the 2408i universal indicator. An optional second process value input allows the average, difference, minimum or maximum of two values to be displayed. Large, bright, red or green displays ensure good visibility in high and low ambient lighting.

Temperature inputs

Temperature can be displayed in Celsius, Fahrenheit or Kelvin. Nine internally stored thermocouple types and the Pt100 resistance thermometer are selectable. Other input linearisations can be factory downloaded.

Pressure inputs

4-20mA transmitter inputs can be powered from an internal 24Vdc supply.

Direct pressure sensor and strain gauge inputs can be energised from an internal 5 or 10Vdc supply. An automatic calibration routine is provided to remove zero and span offsets.

Flow inputs

For flow measurements, square root extraction is available as standard.

Level measurement

Liquid volume in a tank can be derived from a level measurement using an in-built 15-point linearisation curve. The level vs volume measurement is linear up the straight sides of the tank but nonlinear round the curved bottom. The 15-point fit can be applied to any part of the input signal to give an accurate displayed value.

Alarm messages are flashed in the main display and beacons flash for a new alarm and go steady when acknowledged.

Four configurable soft alarms can be individually assigned to either of two process value inputs.

FULL SCALE ALARMS

FULL SCALE HIGH

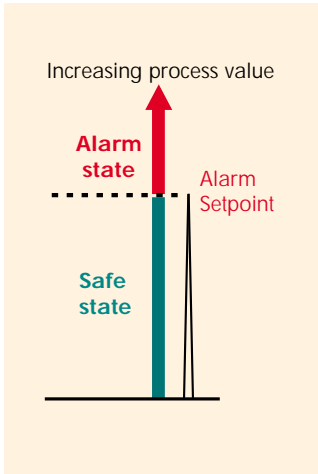

FULL SCALE LOW

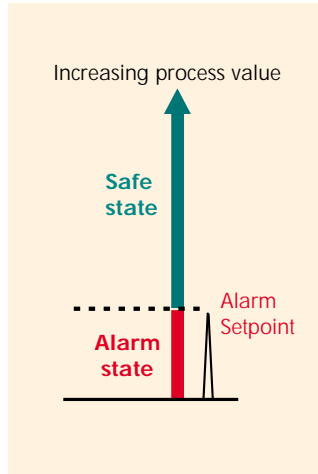

RATE-OF-CHANGE ALARMS

RATE OF INCREASE

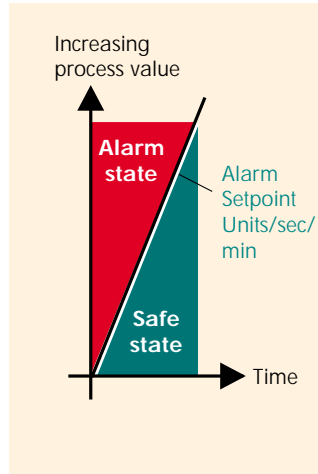

RATE OF DECREASE

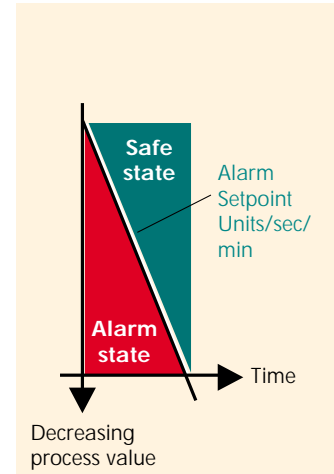

DEVIATION FROM SETPOINT ALARMS

DEVIATION HIGH

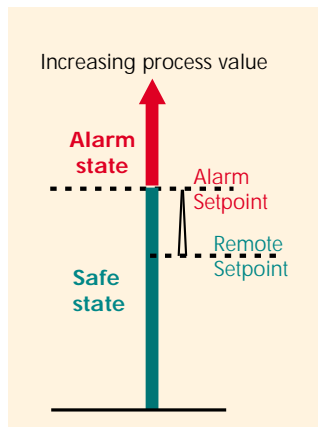

DEVIATION LOW

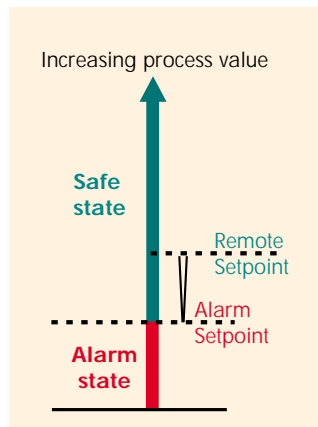

DEVIATION BAND

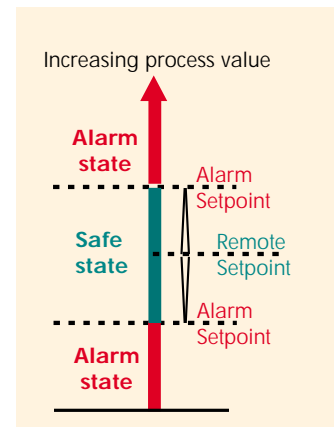

Deviation alarms

Deviation alarms operate on the difference between the process value and a remote setpoint input. The setpoint input is normally the retransmitted setpoint output of the product temperature controller. An alarm will be generated if the process value deviates from the setpoint by more than a preset amount. This facility is particularly useful to protect high value product against excess temperature.

Alarm modes

Latching or non-latching operation can be selected and alarm delays can be applied. A special mode known as 'alarm blocking' is available. In this mode, after power on the alarm must first enter a safe state before the alarms will become active. This is particularly useful for low alarms which can be 'blocked' while the process is warming-up.

Up to four alarms can be combined on to one output:

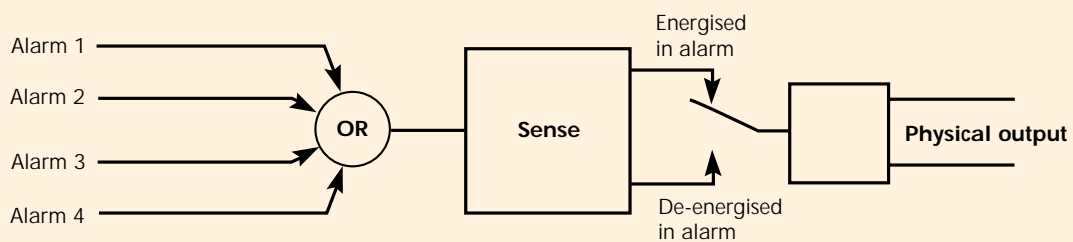

Combining alarms on to an output

Electrical Connections

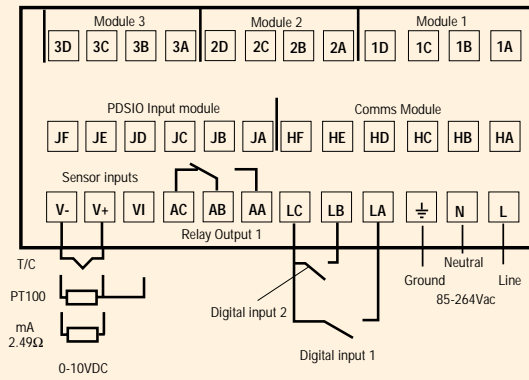

The 2408i has a modular hardware build which accepts a wide range of plug-in I/O modules - see the ordering code for module types available.

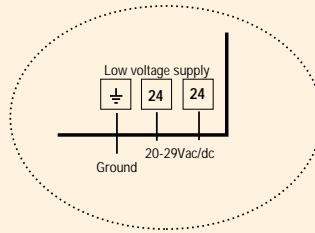

Dimensional details

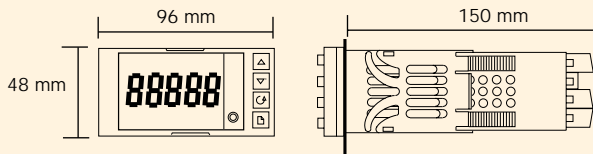

Panel cut-out	
-0.0	-0.0
0.8	0.6
92	x 45

Technical Specification

All inputs and outputs are isolated unless otherwise stated

Main process value input and second DC input

Low level range	-100 to +100mV
High level range	0-20mA or 0-10Vdc
Sample rate	9Hz
Resolution	<2μV for low level inputs <0.2mV for high level inputs
Linearity	Better than 0.2°C
Calibration accuracy	±0.2% of reading, or ±1°C or ±1LSD, whichever is the greater
User calibration	Low and high offsets can be applied
Input filtering	OFF to 999.9 seconds
Thermocouple types	Refer to the ordering code sensor input table
Cold Junction compensation	In automatic mode, >30 to 1 rejection of ambient temperature change OR external 0°C, 45°C, 50°C external references
3-wire Pt100 input	Bulb current: 0.3mA. Up to 22ohm in each lead without error
2nd analogue input functions	2nd process value, remote setpoint, select min, select max, derived value
Custom curve	15 point, user selectable

Digital inputs

Contact closure or open collector inputs

Note: these are powered by the controller	
Digital inputs 1 & 2 (Non isolated from PV)	Switching voltage/current: 24Vdc/20mA nominal Off state resistance < 100ohms On state resistance > 28Kohm
Triple contact closure inputs (isolated)	Specification is as per digital inputs 1 & 2

Externally powered inputs

Triple logic inputs	Off state: <5Vdc On state: 10.8 to 30Vdc @ 2.5mA
---------------------	---

Digital input functions

As per digital inputs 1 & 2 in the ordering code

Digital outputs

Relay rating	2A, 264Vac resistive
Triple logic output	8mA, 12Vdc per channel
Digital output functions	As per the ordering code

DC retransmission

Range	Scaleable between 0-20mA and 0-10Vdc
Resolution	1 part in 10,000
Retransmission values	Process value, setpoint or error from setpoint

Transmitter supply

Rating	20mA, 24Vdc
--------	-------------

Strain gauge bridge supply

Bridge voltage	Software selectable, 5 or 10Vdc
Bridge resistance	300Ω to 10KΩ

Alarms

Number of alarms	Four
Alarm types	High, low, deviation high, deviation low, deviation band, rate of change in units/sec, rate of change in units/min. New alarm status. Sensor break alarm.
Selectable Alarm modes	On input 1, input 2 and main PV. Latching or non-latching. Blocking. Energised or de-energised in alarm
Alarm delay	OFF to 999.9 secs

Communications

Module types	RS232, 2-wire RS485 and 4-wire RS485
Protocols	Modbus®, EI-Bisynch (ASCII) or Profibus-DP

PDSIO

Functions	Remote setpoint input from master controller
-----------	--

General

Display colour	Red or green
Number of digits	Five with up to three decimal places
Supply	100 to 240Vac -15%, +10% OR 24Vdc or ac -15%, +20%. 15W max.
Power consumption	0 to 55°C and 5 to 95% RH non-condensing
Operating ambient	-10 to +70°C
Storage temperature	IP65
Panel sealing	96W x 48H x 150D
Dimensions (mm)	400g max
Weight	EN50081-2 & EN50082-2 generic standards for industrial environments
EMC standards	Meets EN61010, installation category II, pollution degree 2
Safety standards	Not suitable for use above 2000m or in explosive or corrosive atmospheres.
Atmospheres	

Ordering Code

Hardware

Model Number	Function	Display Colour	Supply Voltage	Module 1	Module 2	Module 3	Relay Output 1	Comms Module	PDS Module	Manual
2408i										

Function	Module 1, 2 & 3	Relay Output 1	Comms Module
AL Indicator/Alarm unit AP Profibus Indicator/Alarm unit	XX None R4 Relay (change over) OR Fitted unconfigured OR Select alarm configuration from table A DC Retransmission D6 Fitted unconfigured D6 First character V- PV retrans S- Setpoint retrans Z- Error retrans Second character -1 0-20mA -2 4-20mA -3 0-5V -4 1-5V -5 0-10V Dual relay (note 2) RR Fitted unconfigured	XX Not fitted RF Fitted unconfigured OR select alarm configuration from Table A Table A Alarm relay configuration (note 1) Non-latched alarm (PV1) FH High alarm FL Low alarm DB Dev. band alarm DL Dev. low alarm DH Dev. high alarm RA Rate-of-change alarm Latched alarm (PV1) HA High alarm LA Low alarm BD Dev. band alarm WD Dev. low alarm AD Dev. high alarm RT Rate-of-change alarm NW New alarm	XX Module not fitted RS232 A2 Fitted unconfigured AM Modbus protocol AE El-Bisynch protocol* RS485 (2-wire) Y2 Fitted unconfigured YM Modbus protocol YE El-Bisynch protocol* RS422 (4-wire) F2 Fitted unconfigured FM Modbus protocol FE El-Bisynch protocol* Profibus Module PB High speed RS485 * Not available with Profibus units
Display Colour GN Green display RD Red display	G3 5V supply G5 10V supply 2nd analogue input (module 3 only) D5 Module fitted For configuration see 'PV Function' field below	PDS Module XX Module not fitted M6 Fitted unconfigured RS Setpoint input	Manual XXX No manual ENG English FRA French GER German NED Dutch SPA Spanish SWE Swedish ITA Italian

Note 1:
By default, alarm 1 will be assigned to relay output 1 and alarms 2, 3 and 4 to modules 1, 2 and 3 respectively.

Note 2:
The allocation of alarms to the dual relay outputs is performed in configuration by the customer.

Note 3:
Triple contact or logic inputs can be configured, by the user, for any of the functions listed under Digital Inputs 1 and 2.

Note 4:
The triple logic outputs can be configured as alarm outputs or as telemetry outputs via digital communications.

Note 5:
By default, the transducer supply for input 1 will be installed in module position 2 and the transducer supply for input 2 in module position 1.

Configuration

Configuration of Main Input					Digital Input 1		Digital Input 2		Configuration of 2nd Analogue input (requires D5 in module 3)			
Sensor Input	Setpoint Min	Setpoint Max	Display Units	Options	Digital Input 1	Digital Input 2	2nd DC Input	PV Function	2nd Input Display Min	2nd Input Display Max	2nd Input Display Min	2nd Input Display Max
	note 6	note 6					note 7		note 8	note 8		

Sensor Input & 2nd DC Input		Setpoint Min	Setpoint Max	Display Units	PV Function
Standard Sensor Inputs		Min	°C	Max	
J	J Thermocouple	-210		1200	
K	K Thermocouple	-200		1372	
T	T Thermocouple	-200		400	
L	L Thermocouple	-200		900	
N	N Thermocouple-Nicrosil/Nisil	-250		1300	
R	R Thermocouple-Pt/Pt13%Rh	-50		1768	
S	S Thermocouple-Pt/Pt10%Rh	-50		1768	
B	B Thermocouple-Pt/Pt30%Rh -6%Rh	0		1820	
P	Platinel II Thermocouple	0		1369	
Z	RTD/PT100 DIN 43760	-200		850	
Factory Downloaded Input		Min	°C	Max	
C	C Thermocouple - W5%Re/W26%Re (Hoskins)	0		2319	
D	D Thermocouple - W3%Re/W25%Re	0		2399	
E	E Thermocouple	-270		1000	
1	Ni/Ni18%Mo Thermocouple	0		1399	
2	Pt20%Rh/Pt40%Rh Thermocouple	0		1870	
3	W/W26%Re (Engelhard) Thermocouple	0		2000	
4	W/W26%Re (Hoskins) Thermocouple	0		2010	
5	W5%Re/W26%Re (Engelhard) Thermocouple	10		2300	
6	W5%Re/W26%Re (Bucose) Thermocouple	0		2000	
7	Pt10%Rh/Pt40%Rh Thermocouple	200		1800	
8	Exergen K80 I.R. pyrometer	-45		650	
Process Inputs (Scaled to setpoint min and max)		Min	°C	Max	
F	-100 to +100mV linear	-9999		99999	
Y	0 to 20mA linear (note 9)	-9999		99999	
A	4 to 20mA linear (note 9)	-9999		99999	
W	0 to 5Vdc linear	-9999		99999	
G	1 to 5Vdc linear	-9999		99999	
V	0 to 10Vdc linear	-9999		99999	
Options					
XX	Standard config.				
MP	Melt pressure				
SG	Strain gauge				
CL	Custom linearisation				
Digital Inputs 1 & 2					
XX	Disabled (telemetry only)				
AC	Alarm acknowledge				
KL	Keylock				
SR	Remote setpoint select				
PV	Select process value I/P 2				
J1	Initial tare correction on strain gauge input 1				
J2	Initial tare correction on strain gauge input 2				
J3	Automatic zero and span calibration for strain gauge, input 1				
J4	Automatic zero and span calibration for strain gauge, input 2				

Note 6:
Setpoint min and max: Include the decimal points required in the displayed value; up to one for temperature inputs, up to two for process inputs.

Note 7:
Select the code required from the Sensor Input table.

Note 8:
These two fields are used to scale the 2nd DC Input if it is a linear process input, otherwise it should be left blank.

Note 9:
For mA inputs, a 1% 2.49ohm current sense resistor is supplied as standard. If greater accuracy is required a 0.1% resistor can be ordered as part number: SUB2K/249R.1

Example ordering code:

2408i - AL - GN - VH - RR - RR - XX - XX - YM - XX - ENG - K - 0 - 1000 - C - AC - KL

2408i, Indicating alarm unit, green display, 85 to 264Vac, Dual relay, Dual relay, RS485, Modbus@comms, English manual, Type K thermocouple, 0 to 1000°C, Alarm acknowledge, Keylock

EUROTHERM LIMITED <http://www.eurotherm.co.uk>

UK SALES OFFICE

Eurotherm Ltd

Faraday Close Durrington Worthing BN13 3PL United Kingdom

Sales and support: Tel. +44 (0)1903 695888 Fax +44 (0)1903 695666

Sales and support in over 30 countries worldwide

Enquiries/orders to:

Eurotherm Ltd Faraday Close Durrington

Worthing BN13 3PL United Kingdom

Tel. +44 (0)1903 268500 Fax +44 (0)1903 265982

© Copyright Eurotherm Limited 2000

All rights strictly reserved. No part of this document may be stored in a retrieval system, or any form or by any means without prior written permission from Eurotherm Limited. Every effort has been taken to ensure the accuracy of this specification. However in order to maintain our technological lead we are continuously improving our products which could, without notice, result in amendments or omissions to this specification. We cannot accept responsibility for damage, injury loss or expenses resulting therefrom.

