

# PU202

## Encoder Signal Generator and Level Converter

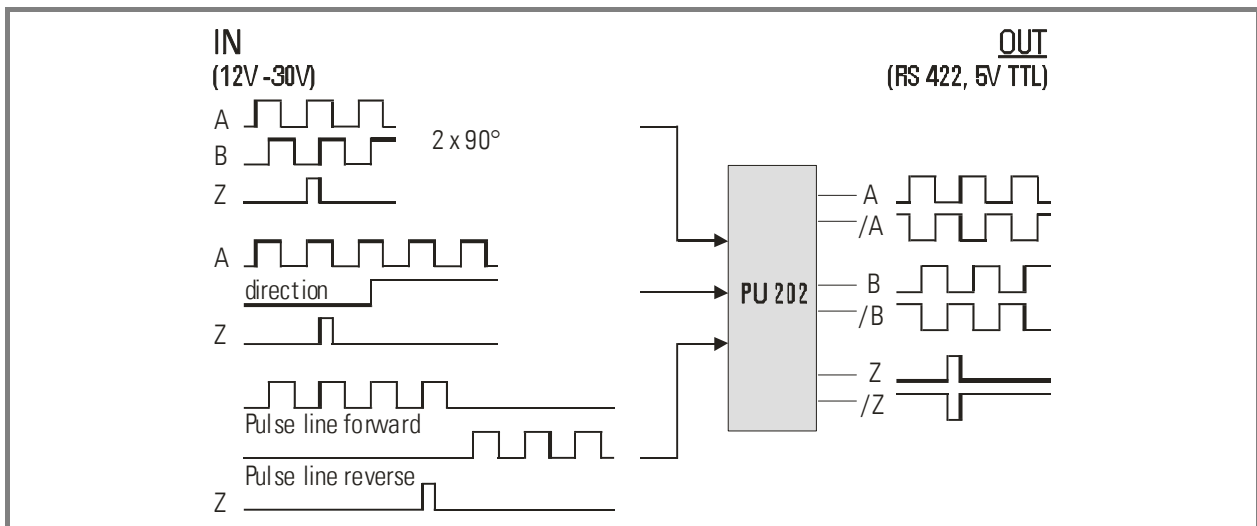

## Operating Instructions

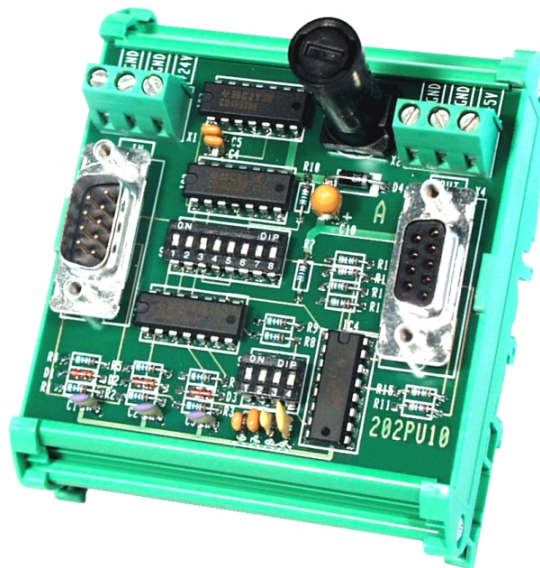

## Safety Instructions

- This manual is an essential part of the unit and contains important hints about function, correct handling and commissioning. Non-observance can result in damage to the unit or the machine or even in injury to persons using the equipment!
- The unit must only be installed, connected and activated by a qualified electrician
- It is a must to observe all general and also all country-specific and application-specific safety standards
- When this unit is used with applications where failure or mal operation could cause damage to a machine or hazard to the operating staff, it is indispensable to meet effective precautions in order to avoid such consequences
- Regarding installation, wiring, environmental conditions, screening of cables and grounding, you must follow the general standards of industrial automation industry
- - Errors and omissions excepted –

Version:	Description:
PU20202c/Sept.07/hk	Remake as brochure with A5 format

# Table of Contents

1. Introduction.....	4
2. Construction, Dimensions.....	4
3. Power Supply .....	5
4. Connections .....	5
5. Modes of Operation.....	6
5.1. Quadrature Input A/B .....	6
5.2. Impulses online A only, static direction select line .....	6
5.3. Separate impulse lines for forward and reverse.....	6
6. Output Signal .....	7
7. Technical Specifications .....	8

# 1. Introduction

PU 202 is designed for conversion of HTL impulse Signals (10-30V) to RS 422 Standard or TTL level, including complements. Also, the unit can translate different modes of direction control to the A/B quadrature mode (2x90°), which is required for the majority of controllers.

Some measuring systems or PLC positioning cards generate pulses on one line whilst another line provides static information of the direction of rotation.

Other systems use two separate lines, one to transmit the forward pulses and the other to transmit the reserves pulses.

The PU 202 converter can translate any of these formats to the usual A/B quadrature standard, as shown in the title drawing.

# 2. Construction, Dimensions

The unit is designed as a PCB with a plastic frame for direct and easy DIN rail mounting.

The impulse inputs are available on a 9-pin Sub-D-connector (female). For power supply of the unit and of encoders, two 3-way screw terminals are available.

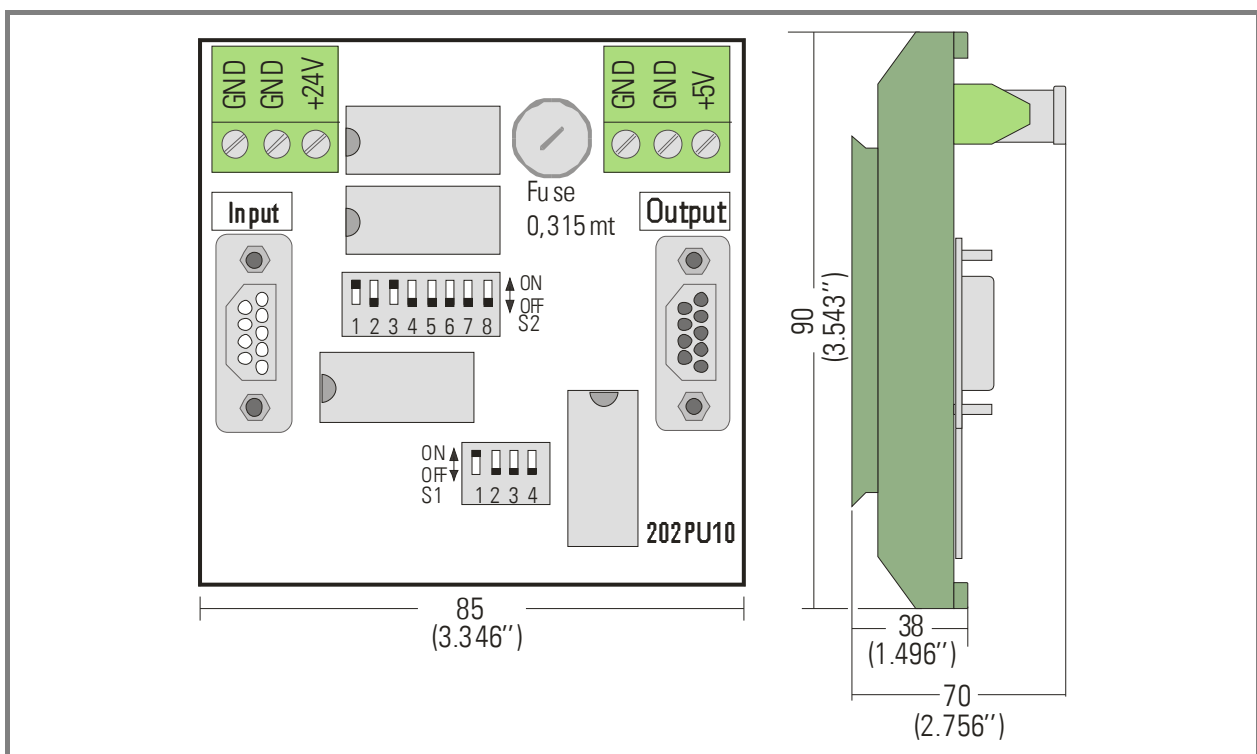



# 5. Modes of Operation

The output signals are always the same, independent of the mode of operation, but the inputs may have different functions. The mode can be selected by the 8-position DIL-switch S2. The index pulse (Z) will only be converted to TTL-level, but not be affected by the mode setting.

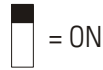

## 5.1. Quadrature Input A/B

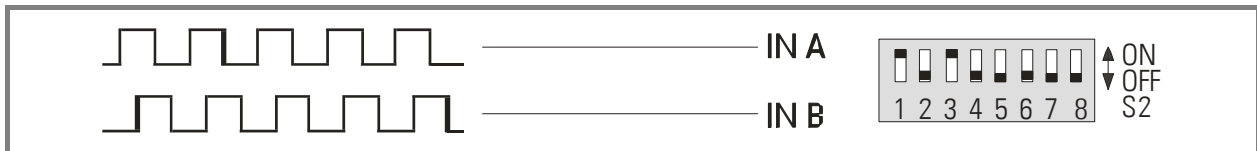

## 5.2. Impulses on line A only, static direction select on line B

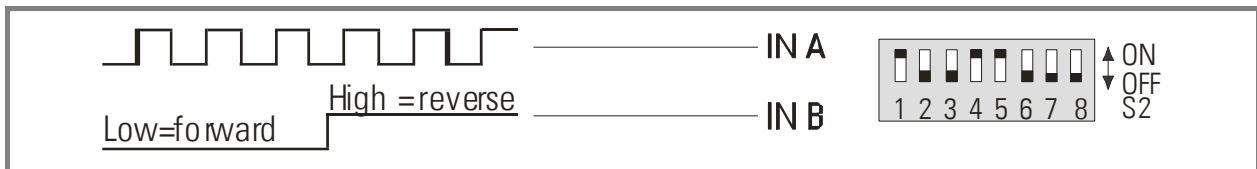

## 5.3. Separate impulse lines for forward and reverse

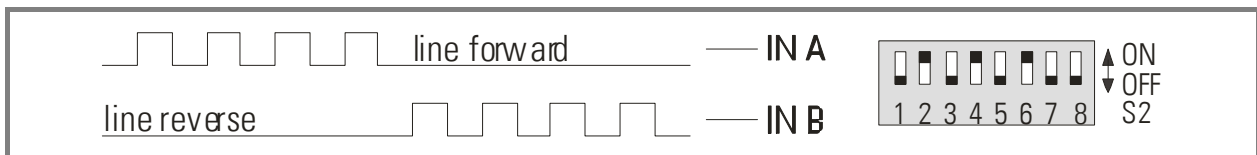

This mode of operation requires that one of the two inputs is in Low state while the other input line receives the pulses.

## 6. Output Signal

The quadrature output operates with a phase displacement between signals A/A' and B/B'. When your input signal is of quadrature type with 90° according to 5.1, your output appears with the same displacement of 90°.

However, with inputs according to 5.2 and 5.3, the phase displacement at the output will be **constant in time**, therefore will correspond to 90° only at a certain input frequency and will become smaller with lower input frequencies.

This in general, this is not a restriction for proper detection of the direction, because most of the controllers can clearly interpret this information, even when the phase is barely visible on an oscilloscope.

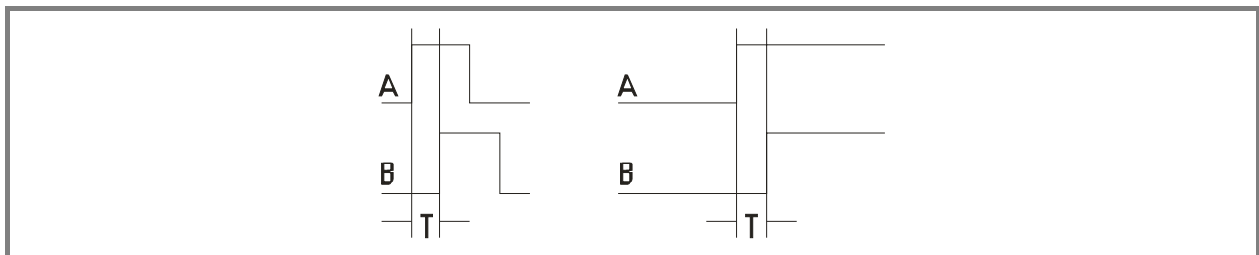

DIL switch S1 permits selection of 5 different times. The frequency is shown in brackets at which the phase displacement corresponds to 90°.

ON OFF S1		T = 0,4 μsec. (625kHz)
ON OFF S1		T = 1,1 μsec. (227kHz)
ON OFF S1		T = 4 μsec. (62,5kHz)
ON OFF S1		T = 11 μsec. (22,7kHz)
ON OFF S1		T = 40 μsec. (6,25kHz)

## 7. Technical Specifications

Power supply	:	5VDC +/-10%
Supply current	:	approx. 50 mA
Max. frequency	:	200 kHz
Input	:	HTL 10-30V, PNP (int. pull-down = 10kOhm)
Output	:	TTL differential A, /A, B, /B, Z, /Z, (20 mA)
Delay time In/Out	:	approx. 800 nsec.
Temperature range	:	0°C - 45°C (32°F - 113°F)
Dimensions	:	See drawing page 4
Weight	:	approx. 100g
Conformity and standards	:	EMC 89/336/EEC: EN 61000-6-2 EN 61000-6-3 LV73/23/EEC: EN 61010-1